



specializing in “AIR CONDITIONING, PARTS AND SYSTEMS” for your classic

## ***“PERFECT FIT” IN-DASH***

### **HEAT/ COOL/ DEFROST 1964-66 FORD THUNDERBIRD**

#### **CONTROL & OPERATING INSTRUCTIONS**

The controls on your new “Perfect Fit” system. Offers complete comfort capabilities in virtually every driving condition. This includes Temperature control in all of the modes. This system also provides DEHUMIDIFICATION in the defrost mode.

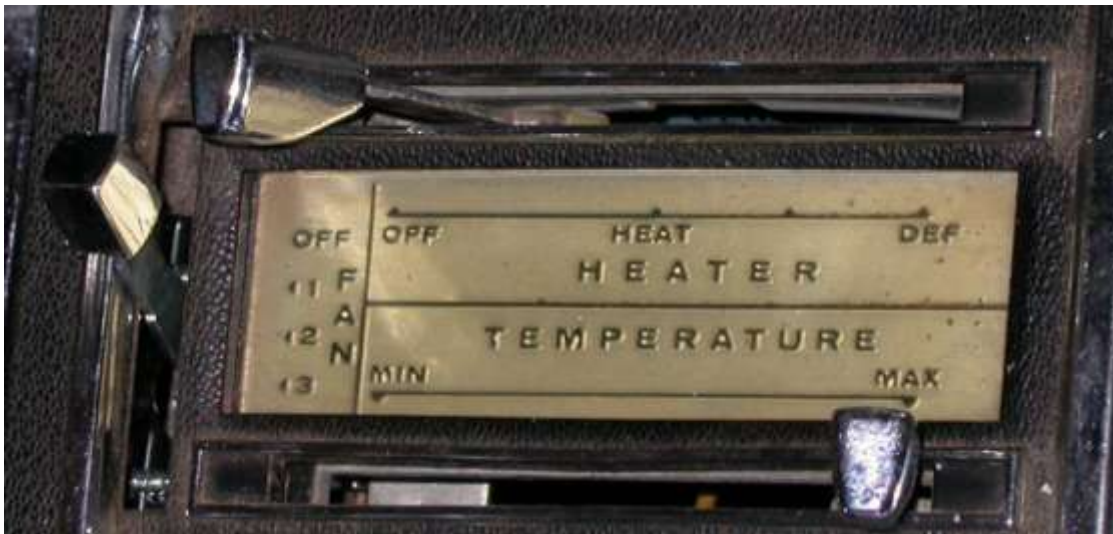

**CAUTION:** ALL OF THE OUTSIDE VENTS MUST BE CLOSED WHEN THE SYSTEM IS IN THE A/C MODE. THIS WILL ALLOW THE A/C SYSTEM TO FUNCTION AT ITS MAXIMUM PERFORMANCE LEVEL.

THE FOLLOWING SUMMARY WILL DESCRIBE EACH OF THE CONTROL LEVERS FUNCTION.

***FAN SPEED SWITCH:*** There are 3 speeds plus Off. When the switch is in the off position it will disconnect the 12V power to the Blower Motor and the A/C Clutch. This will shut down the entire system. When the switch is moved to any of the blower speeds 1, 2 or 3 there is 12V supplied to the Micro-Switch that is mounted on the Defrost Duct.

***FACE / DEFROST / HEAT DOOR CONTROL:*** When the Control Knob is pushed all the way to the LEFT the air is distributed to the FACE outlets. In the FACE position the compressor is engaged. When the knob is pushed to the MIDDLE of the controls the air will go to the DEFROST outlets. In the Defrost position the compressor clutch is engaged for dehumidification. When the knob is pushed all the way to the RIGHT the air will go to the HEAT outlets.

***TEMPERATURE CONTROL:*** The Temperature Knob as shown is at the HOTTEST temperature position. As the lever is PUSHED to the LEFT the temperature of the discharged air will FALL to the COLDEST point.

Note: The temperature lever will function in any of the modes.



specializing in “AIR CONDITIONING, PARTS AND SYSTEMS” for your classic

## ***INSTALLATION INSTRUCTIONS 1965 FORD THUNDERBIRD***

Congratulations!! You have just purchased the highest quality, best performing A/C system ever designed for you Classic Car. To obtain the high level of performance and dependability our systems are known for, pay close attention to the following instructions.

Before beginning the installation check the box for the correct components.

Evaporator  
Distribution Duct Assembly  
Flex Hose 2”dia. x 3ft. (2 pcs)  
Flex Hose 2 1/2” dia. x 3ft.  
Block off Air Inlet  
Sack Kit Hardware  
Sack Kit Control  
Control Cables (2)

### ***IMPORTANT INFORMATION***

1. Before starting, read the instructions carefully and follow proper sequence.
2. Check condition of engine mounts. Excessive engine movement can damage hoses to A/C, heater, radiator, trans cooler, and power steering systems.
3. Before starting, check vehicle interior electrical functions. i.e. interior lights, radio, horn, etc. When ready to start installation, disconnect battery.
4. Fittings. Use one or two drops of lubricant on O’rings, threads and rear of bump for O’ring where female nut rides. Do not use thread tape or sealants.
5. Always use two wrenches to tighten fittings. Try holding in one hand while squeezing together while other hand holds fitting in position.
6. Shaft seals in a small percentage of compressors will require as much as 3-4 hours run time to become leak free.
7. Compressors supplied in our complete systems are filled with proper amount of oil.
8. Compressor requires technician to hand turn 15-20 revolutions before and after charging with liquid from a charging station before running system. Compressors with damaged reed valves cannot be warranted.
9. Should you have any technical questions, or are suspect of missing, or defective parts, call us immediately. Our knowledgeable staff will be glad to assist you.

***YOU CAN NOW BEGIN THE INSTALLATION***

**Disconnect battery ground cable. Drain radiator. Remove the top radiator cover panel. Retain original hardware.**

Carefully remove chrome trim strip along passengers dash panel just under the "Thunderbird" emblem.

Remove (3) screws behind the trim. Retain original hardware.

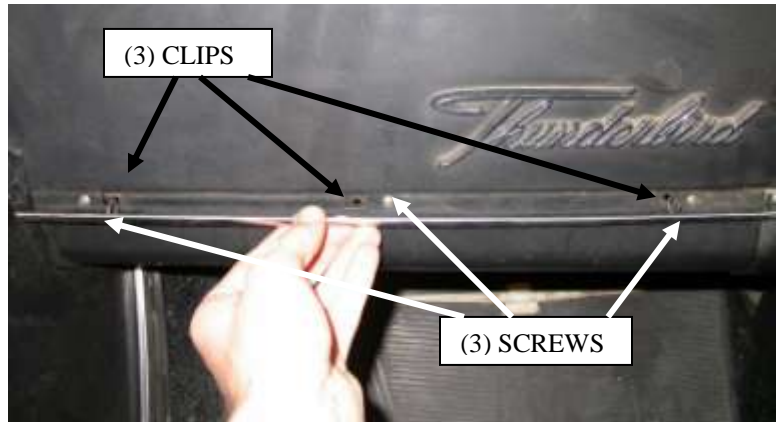

Remove and retain screws along console that holds the lower dash panel.

Remove and retain the screw near the door.



Remove screws along the trim on the console. Remove trim and retain original hardware.

Remove (4) screws that hold the console panel.

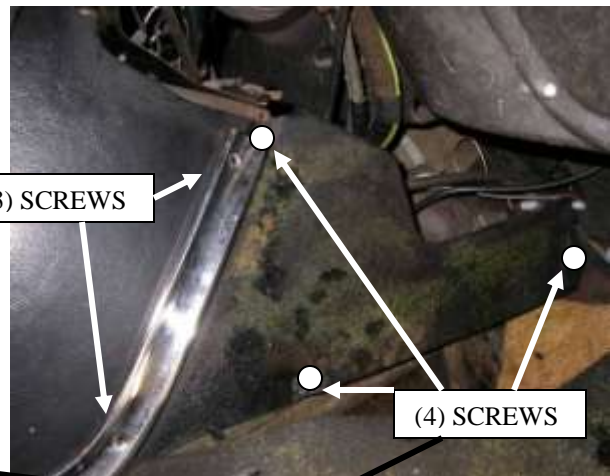
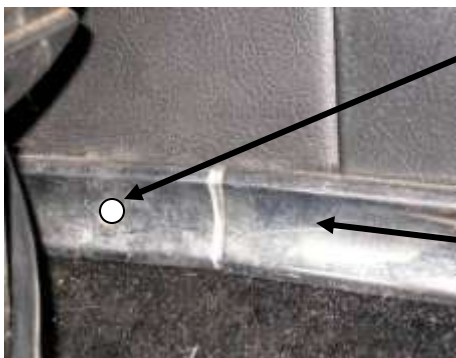

NOTE: SCREW UNDER TRIM

Remove radio knobs and the heater control knobs.  
Retain for later reinstallation.



Remove (6) screws that hold the center console cover.  
NOTE: (2) of the screws are under arm rest.

NOTE: LABEL WIRES TO THE WINDOW AND  
DOOR SWITCHES.



Remove (4) screws that hold controls in  
the dash.



Remove cables from back of the control head.  
Retain original hardware for the cable clamps.

Disconnect wiring from the switch and light.

Remove and retain the control head.

Remove control cable from fresh air inlet box on passenger side of the heater.

Also remove screw that attaches air inlet housing the body.



Remove control cable from center of heater box next to the defrost ducts. Discard the cable.

Remove the defrost duct hoses and discard.

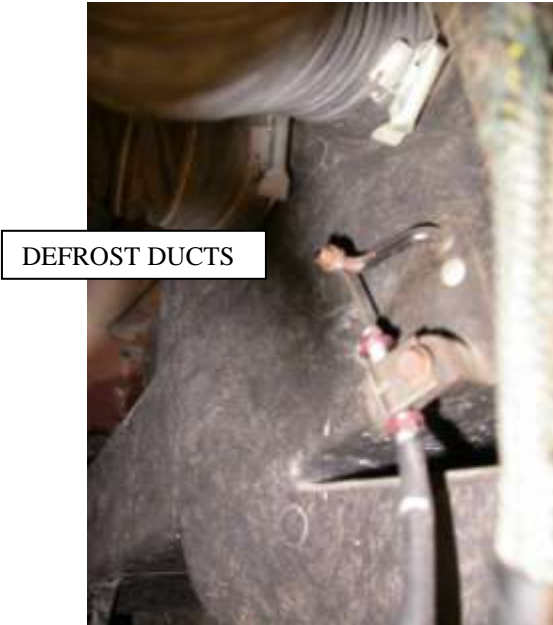

Defrost attachment to diffusers typical drivers and passenger side.



Disconnect electrical plug from resistor on the heater box.

Remove and discard door control cable.



Located along firewall in the engine compartment, is a vacuum canister.

Remove and set aside for later reinstallation. Retain original hardware.

Disconnect heater hoses from heater coil.



Remove blower access cover from the firewall. Retain cover and the original hardware.



Remove (3) nuts from the heater mounting studs.  
(2) around the heater motor opening.  
(1) behind throttle pedal.

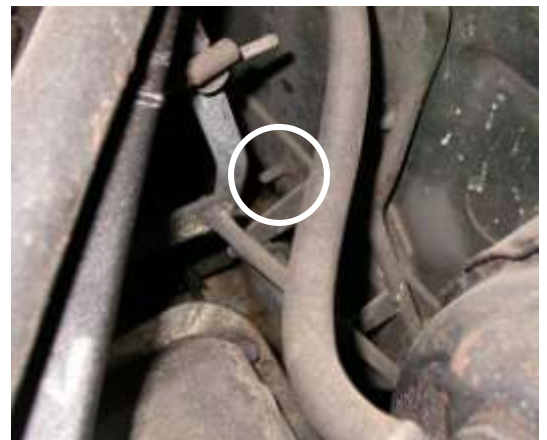

CAREFULLY REMOVE THE HEATER ASSEMBLY. DISCARD.

Locate blower motor service hole on the firewall. Directly below center line of hole drill a 3/4" dia hole at bottom of radius.

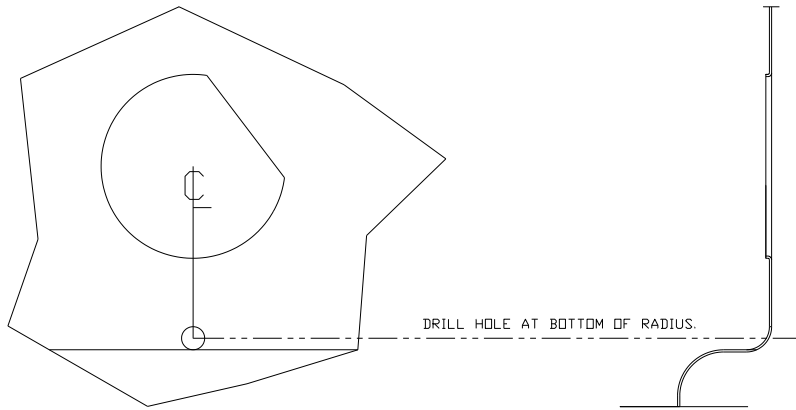

Locate the evaporator, Air Distribution Duct assembly and (4) #10 x 5/8" pan head screws.

Place evaporator on the bench and attach Distribution assembly onto the evaporator using (4) #10 x 5/8" pan head screws.

Locate the evaporator. Slide evaporator under instrument panel and up into place.



Insert heater hoses and a/c tubes through hole in the firewall.

On engine side of firewall attach evaporator to the firewall through the original heater mounting hole using (1) 1/4"-20 x 1" bolt and flat washer.



Loosely install original bolt into the front brace. This will hold unit in place while you attach the blower support brace.

Attach blower support brace to the original air inlet tab. Use the original screw.

Locate (1) #10 x 3/4" tek screw. Attach the support brace to the air inlet using the #10 screw.

Install 6" piece of drain tube through the hole previously drilled.



Locate original service cover, and drill template on the last page of instructions.

Drill out the holes per the template.

Install (2) heater hose grommets as shown.

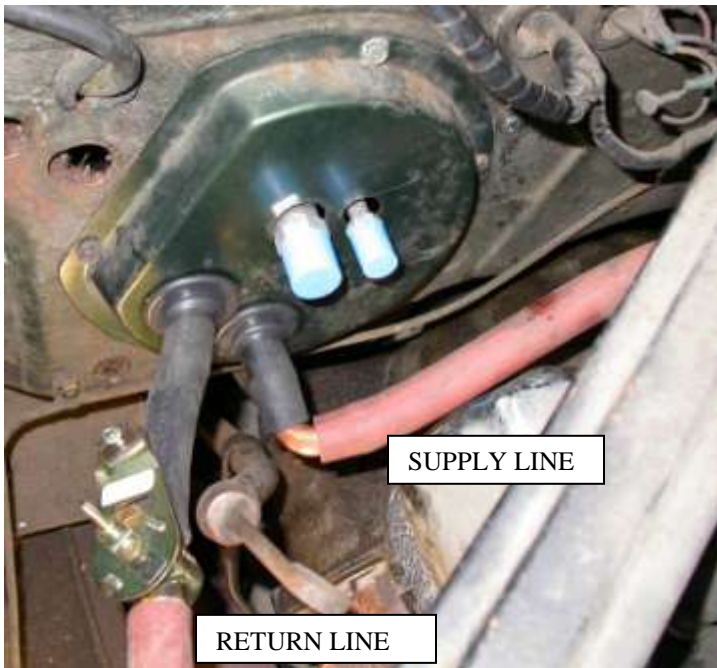

Install service cover inserting heater hoses through the grommets and a/c tubes through the holes.

Attach using the original hardware.

Locate 90 deg hose splice and the water valve.

Attach supply hose from the engine to the 90 deg. Splice. Return line to the engine will attach to the water valve.

Locate the original control head.

Remove and discard original switch. Retain the hardware.





Locate blower switch assembly provided in the kit.

Attach switch using the original hardware,

Locate wire harness supplied in the kit.

Attach harness to blower switch; refer to wiring diagram on the next page.

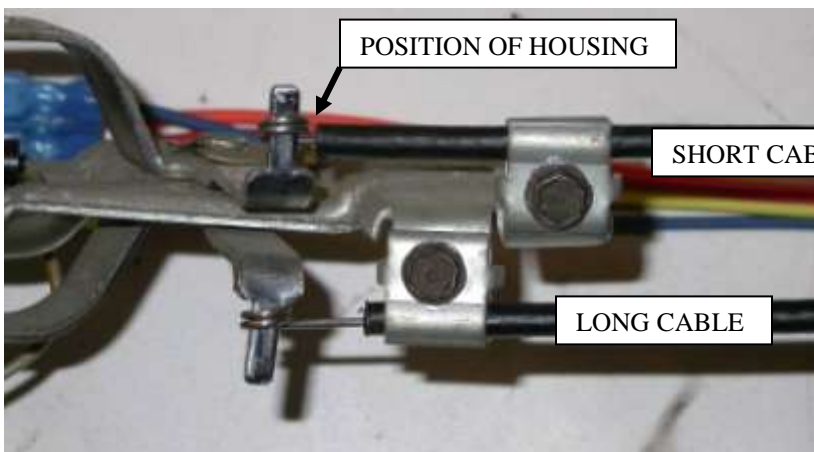
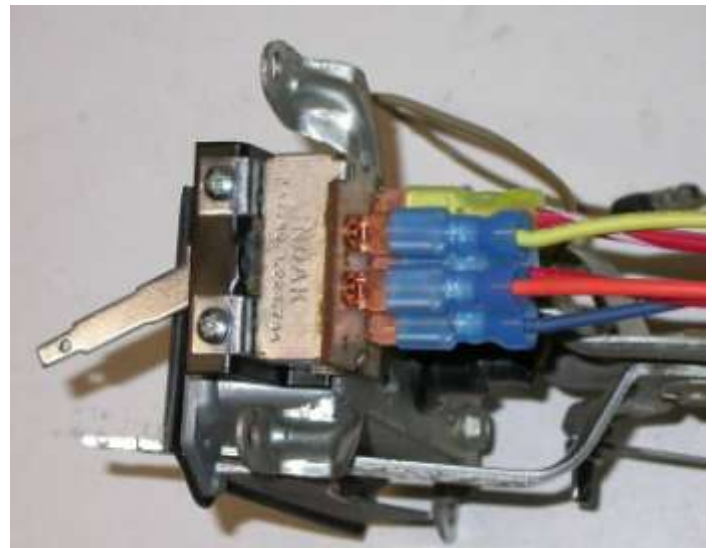

Locate (2) control cables from the kit.

Using original cable clip and hardware attach short cable the top control lever.

NOTE: When lever is in far right position cable housing will touch the pin.

Using original cable clip and hardware attach longest of the control cables to the bottom lever.

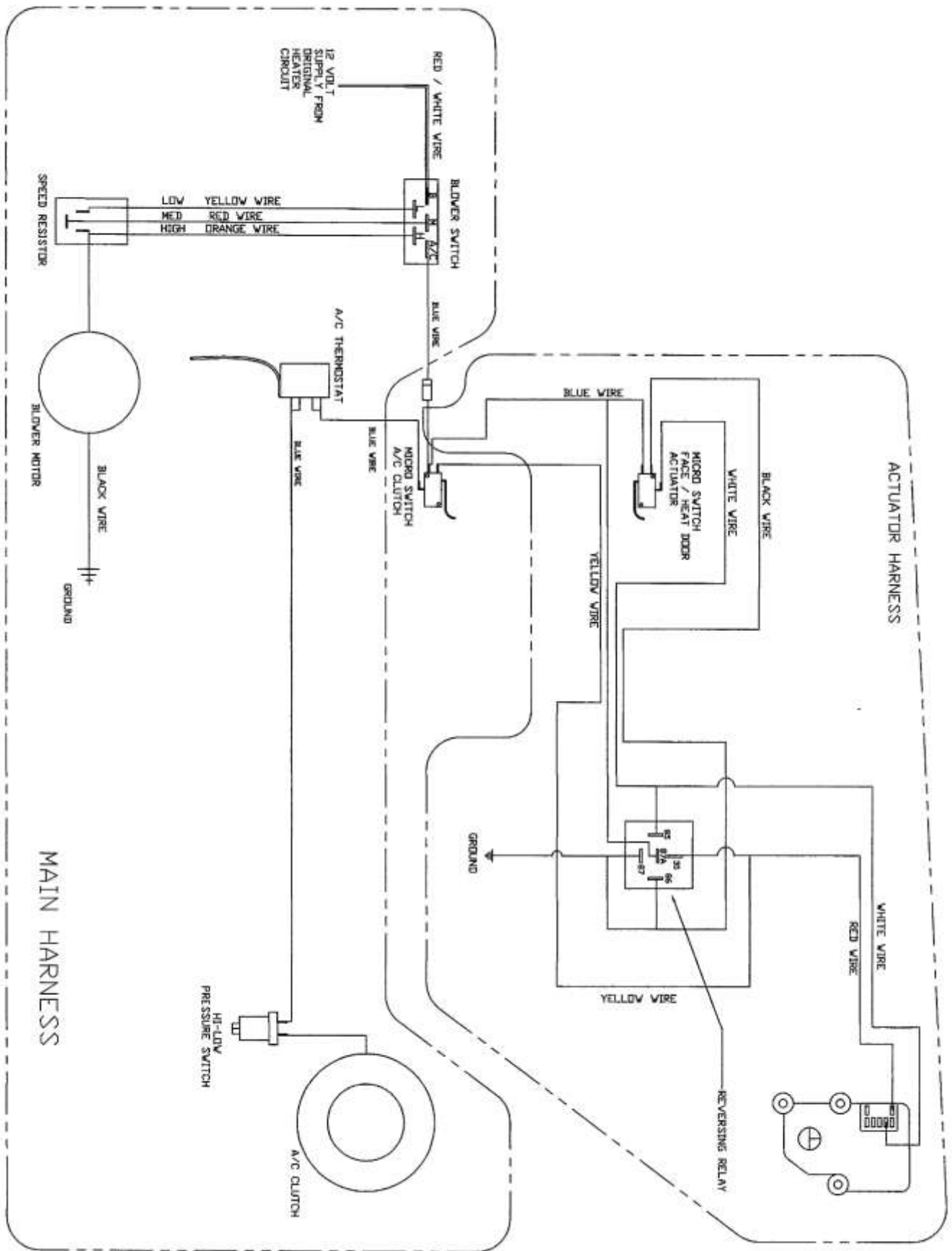



PLUG

Insert electrical wiring and control cables into the center console.

Plug the control head light wires together.

Slide control head into place. Attach using the original hardware.



Route wire harness across to the blower motor.

Attach connectors to the motor, thermostat, and resistor.

Refer to electrical diagram.

Attach ground wire from blower connector to the body using (1) #10 tek screw.



GROUND WIRE



Locate orange wire with bullet connector that was attached to the original blower motor. Cut off the connector and add a ¼" male spade connector.

Plug red/white wire from a/c wire harness to this wire. This is your power wire for the system.

Locate (2) blue wires along the wire harness, route wires to side of the duct assembly.

Attach blue wire from blower switch to the pigtail on the micro switch.

Attach blue wire from thermostat to the open terminal on the left micro switch.

Refer to the wiring diagram.

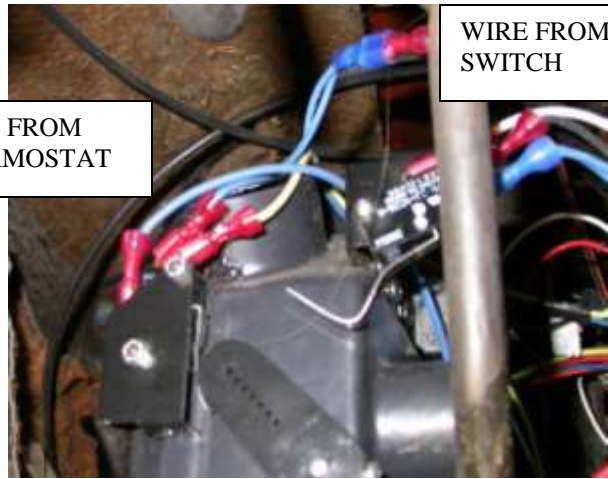

Locate black wire with a ring terminal that is attached to the relay on the duct.

Attach this wire to metal on the dash using (1) #10 tek screw.

Route short cable under distribution duct and around to the Heat / Face door.

Insert cable offset into 2<sup>nd</sup> hole from pivot of the door. Attach cable flag to the bracket using (1) #8 x 3/8" pan head screw.

Check adjustment of the door by moving the control lever from left to right. Be sure that when lever is in the center that the micro switch on the right is depressed.

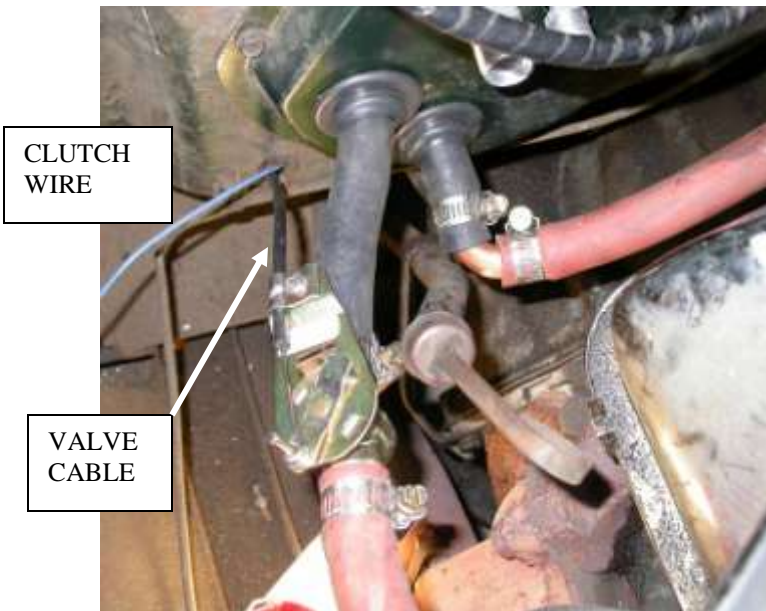

Route longest of the control cables across back of the evaporator and out through original heater mounting hole. Attach to the water valve.

Adjust cable so that when temp lever is all the way to the right the water valve is closed.

Route blue wire from the thermostat over top of the blower and out through same hole as the cable.

Locate (4) #8 worm gear clamps. Attach to water valve and the 90 deg. Splice.

Locate (2) 1 1/8" dia cap plugs and install over holes where original heater hoses hooked to the heater.





Locate in the kit (2) defrost hose adapter, and (4) #8 x 3/8" pan head screws.

Locate 2" dia x 3ft. flex hose and cut (1) piece 16" long and (1) piece 20" long.

Attach 16" hose to defrost hose adapter without the retaining clips using the #8 screws.

Attach 20" hose to the remaining adaptor.

Slide 16" hose assembly over passenger defrost diffuser and route hose over top of the unit and attach other end to the rear defrost air outlet on the duct assembly.

Slide 20" hose assembly over drivers side defrost diffuser and route hose to front air outlet on the duct assembly.



Locate 2" dia x 3ft. flex hose and (2) tywraps.

Cut (2) pieces 14" long and attach to outlets on the distribution duct.

These will route through opening in the instrument panel.



Locate 2 1/2" dia x 2ft. flex hose and cut (2) pieces 14" long.

Slide over front outlets on the distribution duct.

Remove 1/4" of material from both sides of opening.

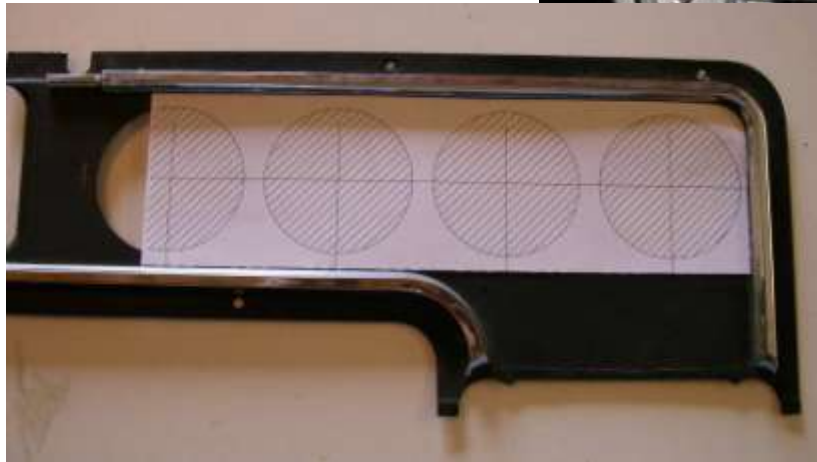

Locate original center trim panel and the "Template CENTER TRIM PANEL".

Cut out template and tape to the panel. Carefully cut (4) 2 1/2" dia holes.

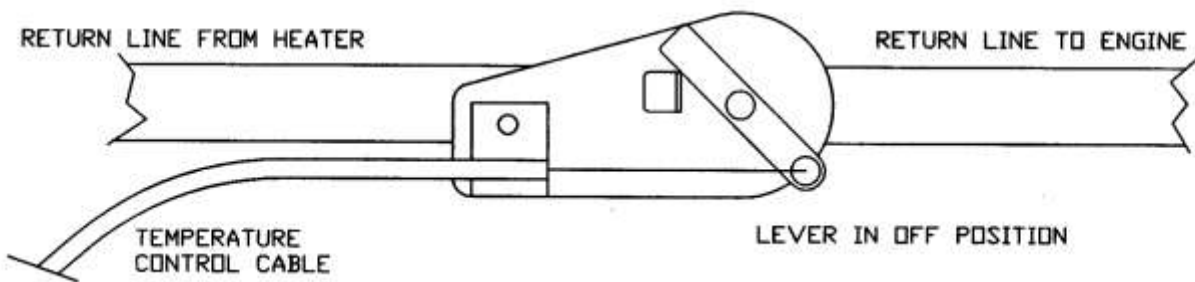

Install (4) round louvers on to the panel.



There are (2) of the louvers that have a 2" hose adapter. These go on the outboard holes.

The (2) louvers with 2 1/2" hose adapters go in the center 2 holes.



Install center trim panel attach (4) flex duct hoses to the hose adapters using (4) #8 x 3/8" pan head Phillips screws.

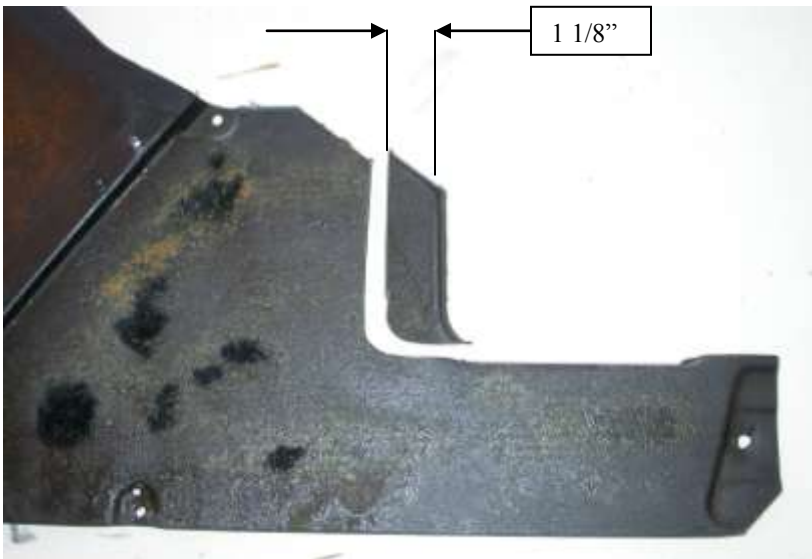

Locate the original passenger side console cover.

Carefully trim 1 1/8" as shown.

**Caution:** Carefully check under the Instrument Panel for all cables, electrical harness, or Flex Hoses that might interfere with the safe operation of the vehicle.

Reinstall all remaining console and dash trim panels using original hardware.

***Install the compressor drive kit at this time.***

***The engine compartment components should be installed at this time. Carefully follow the electrical diagram provided on page 10.***

Locate following components from the condenser kit. Condenser, (2) top condenser mounting bracket, (2) bottom condenser mounting brackets and (8) #10 x 3/8" screws.

Place condenser on the bench with fittings on the left side.

Attach bottom condenser brackets to bottom hole of the condenser. Using the #10 screws.

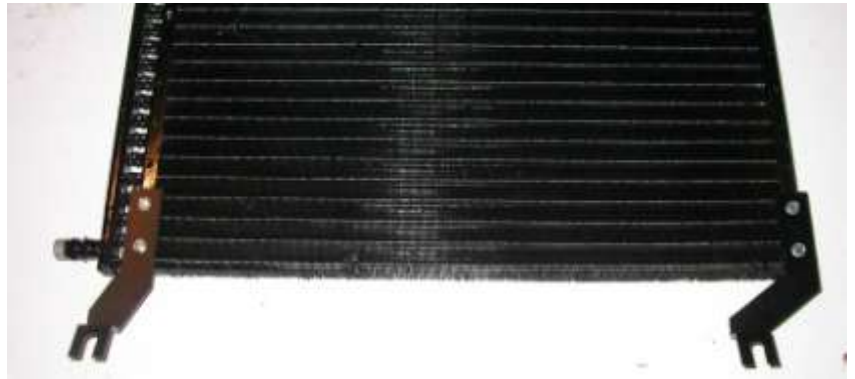

Turn condenser over so that fittings are on the right side.

Attach top condenser brackets to top hole of the condenser. Using the #10 screws

Locate the drier, drier mounting bracket, pressure switch, (1) #6 liquid tube (short),(1) liquid tube (long), (4) #6 o-rings and (2) #10 x 3/8" hex screws.

Attach discharge tube to #8 fitting on the condenser using an o-ring and a few drops of mineral oil.

Attach short liquid tube to #6 fitting on condenser using the o-ring and a few drops of mineral oil. Other end attaches to the to the drier inlet.

Use the tube to locate drier and mounting bracket. Attach using the #10 screws.

Attach long liquid tube to the drier using a #6 o-ring and a few drops of mineral oil.



Slide condenser between radiator and the radiator support. Let hange on the upper brackets.

Install pressure switch on filter drier. Attach the electrical boot to the pressure switch, route white wires across the discharge tube. Tywrap the wires to the tube.



Locate left bottom condenser mounting bracket and slide into the bottom radiator mounting bolt.

Attach right bottom condenser mounting bracket over the 5/16" bolt.

Tighten the condenser bolts.



Locate (1) 3/8" tube clamp and (1) #10 x 3/4" tek screw.

Attach liquid tube to the radiator support using clamp and screw.

**REINSTALL RADIATOR FAN AND SPACER USING THE ORIGINAL HARDWARE.**

Locate #6 liquid hose and (2) #6 o-rings.  
Attach hose between fitting on firewall and fitting on the condenser.



Locate #10 suction hose and (2) #10 o-rings. Attach hose to fitting on the block off and end with the service port to the compressor.



When routing liquid hose attach hose and the return heater hose to shock tower using (1) double clamp and a #10 tek screw.



When routing suction hose tywrap hose to the body brace beside the air cleaner.

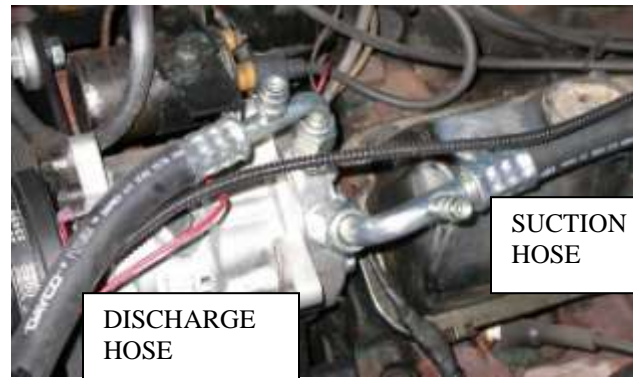

Locate #8 discharge hose and (2) #8 o-ring. Attach end of the hose with 45 deg fitting to the condenser fitting and end with the service port to compressor.

Reinstall the top radiator cover panel using original hardware.



Locate discharge tube support bracket, #8 hose clamp and (1) #10 x 3/8" pan head screw.

Attach bracket to top radiator cover panel. Also attach clamp over discharge tube and onto the bracket using #10 screw.

Locate (2) white wires tywrapped to the discharge tube. Route along the discharge hose. Cut one of the wires and attach female bullet connector provided and plug into the compressor clutch wire.

Other wire route along suction hose and connect to blue clutch wire from the thermostat.

**CAUTION: CHECK AROUND ENGINE TO BE SURE THAT THERE IS NOTHING THAT WILL INTERFERE WITH SAFE OPERATION OF THE VEHICLE.**

***THE ENGINE COMPARTMENT OF YOUR SYSTEM IS COMPLETE.  
THE UNIT IS READY FOR EVACUATION AND CHARGING.***

***THIS SHOULD BE DONE BY A QUALIFIED AND CERTIFIED AIR  
CONDITIONING TECHNICIAN.***

***NOTE: COMPRESSOR IS SUPPLIED WITH THE  
CORRECT OIL CHARGE. DO NOT ADD OIL TO SYSTEM.***

***134a SYSTEMS      24 oz OF REFRIGERANT  
Recommend that power fuse is 25amp minimum***

***Congratulations you have completed the install of your  
CLASSIC AUTO AIR "Perfect Fit Series" system.***





# **IMPORTANT**

**CAUTION: WATER VALVE MUST BE INSTALLED PER THE INSTRUCTIONS.**

Classic Auto Air has done extensive testing on the correct method to install the water valve in order to get a repeatable and progressive temperature control.

Locate the **bottom** connection from the evaporator/heater unit off of the firewall and attach a 6" piece of 5/8" dia. heater hose with the supplied hose clamp. Next attach the inlet side of the water valve using another supplied hose clamp, (make sure the arrow on the water valve points toward the engine) Attach a heater hose from the outlet side of the water valve and route to the connection on the water pump.

**NOTE: WATER VALVE = WATER PUMP**

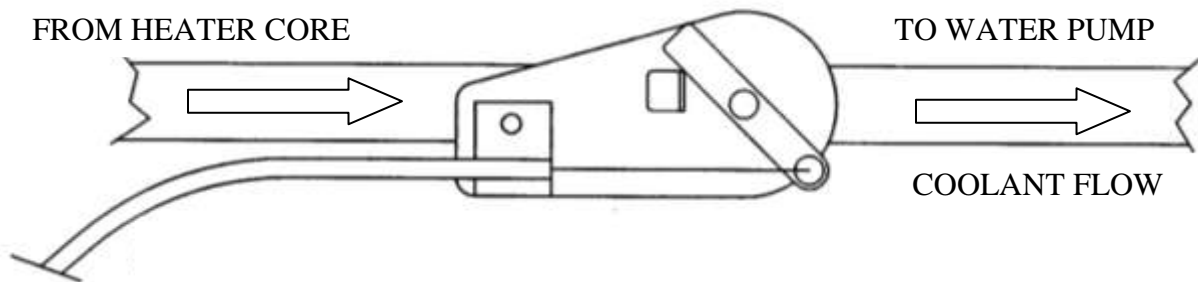

**CAUTION: WATER VALVE MUST BE INSTALLED ON HEATER LINE ROUTED TO WATER PUMP.**

***NOTE: COMPRESSOR PURCHASED WITH KIT IS SUPPLIED WITH THE CORRECT OIL CHARGE. DO NOT ADD OIL TO SYSTEM.***

***134A SYSTEMS      24 oz OF REFRIGERANT  
Recommend that power fuse is 25amp minimum***