

Installation Manual

1967-72 Chevrolet Pickup

DOCUMENT #1-2033 BENCH CALIBRATION INSTRUCTIONS

©2018 Classic Auto Air / 12.18



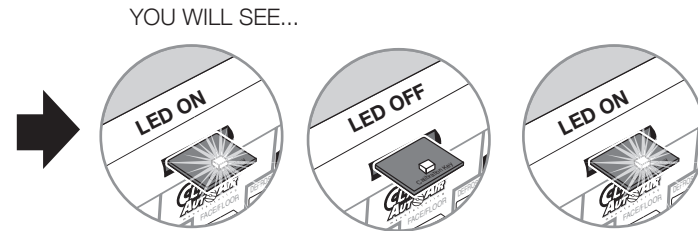
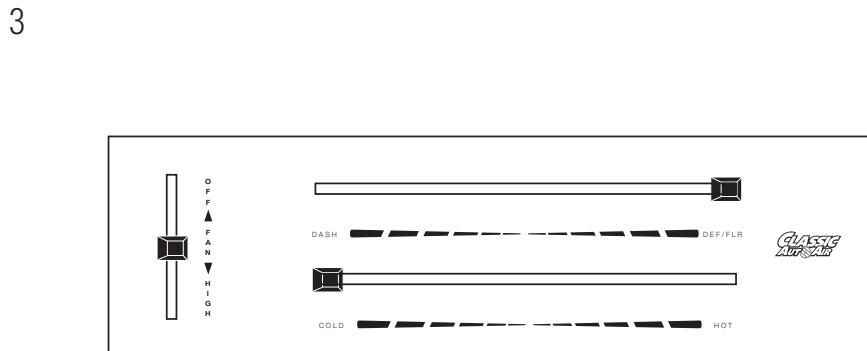
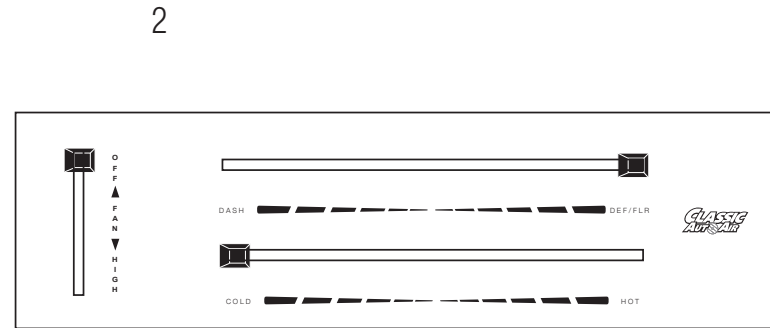
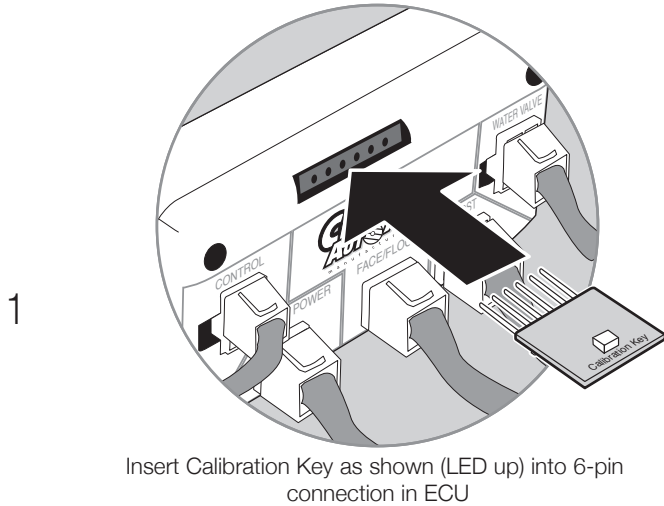

4

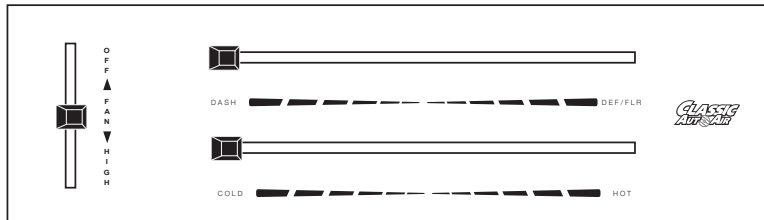

Move MODE knob to DASH
in one motion

AFTER YOU MOVE THE KNOB YOU WILL SEE...

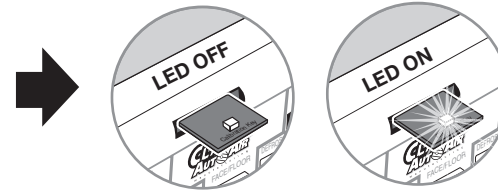

5

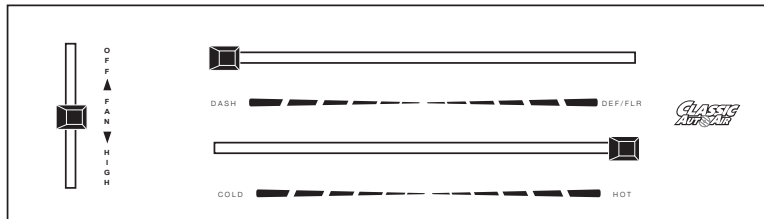

Move TEMP knob to HOT
in one motion

AFTER YOU MOVE THE KNOB YOU WILL SEE...

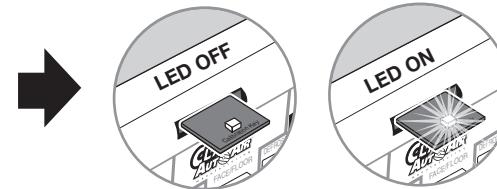

6

You will be able to hear the internal door(s) move back and forth and feel air coming out of the outlets

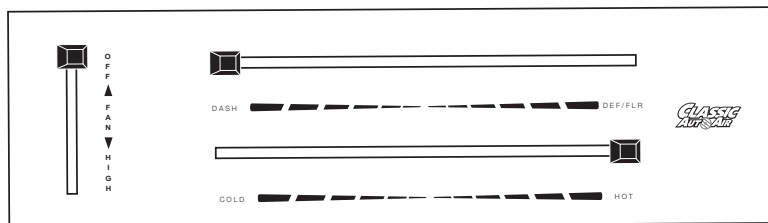
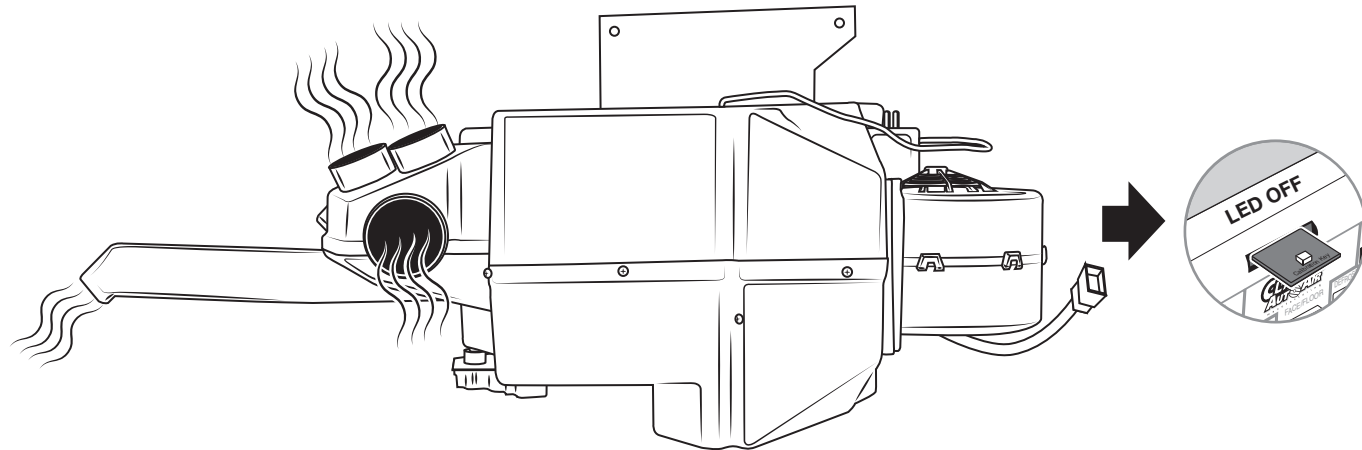

Move FAN knob to OFF

7

8

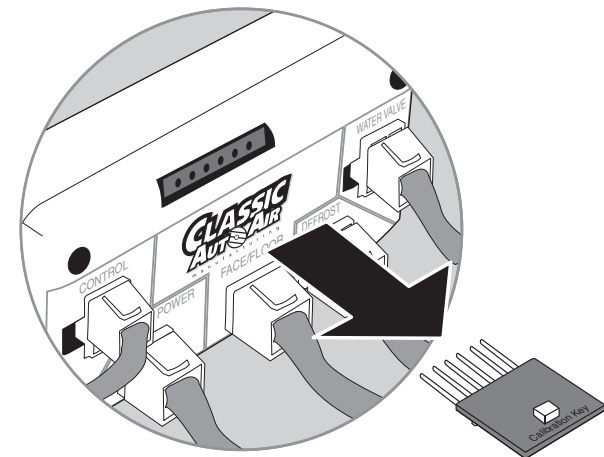

REMOVE CALIBRATION KEY FROM ECU AND STORE IN A SAFE PLACE

